

編號：PG2010HM338R-LL-W

# 承認書

## Approval Sheet

客戶名稱：\_\_\_\_\_

供應商：上海品觀電子有限公司

品名：紅外接收管

規格：HM338R-LL-W

日期：\_\_\_\_\_

客戶承認簽署后請回傳一份至本公司

客戶確認		
審批	品管	技術

上海品觀電子有限公司

地址：上海市徐匯區田州路 159 號蓮花大廈 805 室

電話：021-61912818

傳真：021-61912767

Http://www.pergood.com

E-mail:pinguansh@126.com

## Photo Module for PCM Remote Control Systems

### Description

The HM338RLL-W is a miniaturized receiver for use in Infrared carrier frequency PCM remote control systems. A high quality photo diode and a low noise preamplifier are assembled on lead frame, and the epoxy package is designed as IR filter.

The demodulated output signal can directly be decoded by a microprocessor. The main benefit is the reliable function even in disturbed ambient and the protection against uncontrolled output pulses.

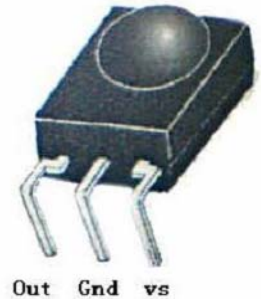

### Features

- Photo detector and Preamplifier in one package
- Internal filter for PCM frequency
- TTL and CMOS compatibility
- Output active low
- Suitable burst length  $\geq 10$  cycles/burst
- Low current consumption 0.35mA 3V
- Operates down to 2.2 Volt
- Lead-Free component in accordance with RoHS directives

### Special Features

- Enhanced immunity against all kinds of disturbance light
- No occurrence of disturbance pulses at the output

### Applications

TV, Set top box, DVD, AV equipments, Air Conditioner, and IR Remote Control system

### Block Diagram

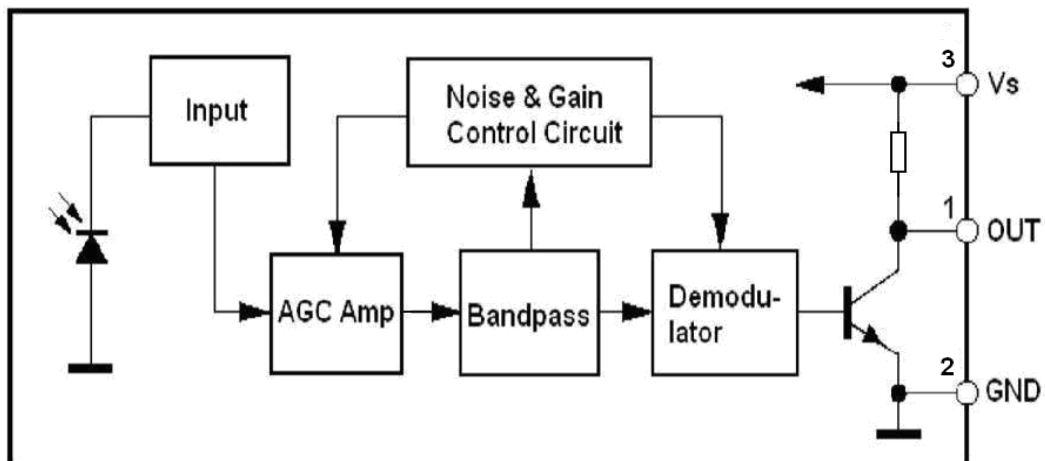

Application Circuit

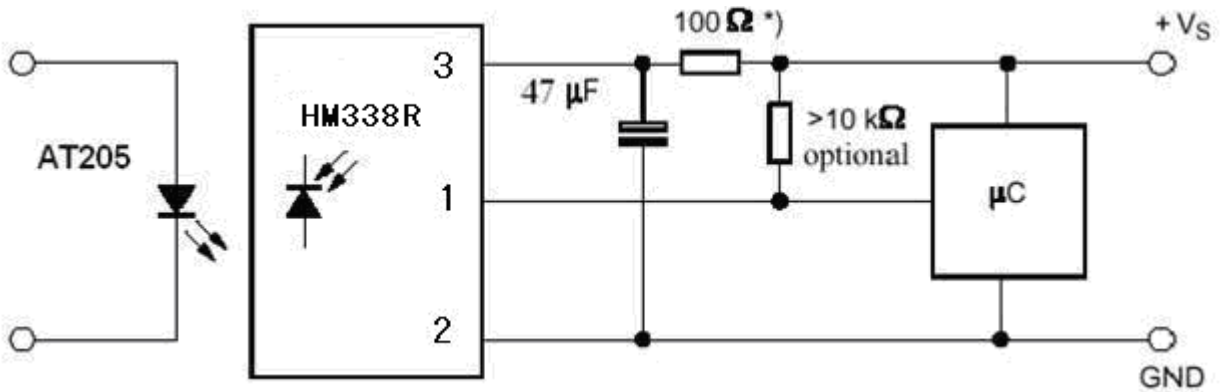

\*) recommended to suppress power supply disturbance

Absolute Maximum Ratings

Tamb = 25 °C

Parameter	Test Conditions	Symbol	Value	Unit
Supply Voltage	(Vs)	Vs	0---6.0	V
Supply Current	(Vs)	Is	5	mA
Output Voltage	(OUT)	Vo	0---6.0	V
Output Current	(OUT)	Io	2.5	mA
Storage Temperature Range		Tstg	-30---+85	°C
Operating Temperature Range		Tamb	-25---+85	°C
Power Consumption	( Tamb ≤85°C)	Ptot	10	mW
Soldering Temperature	t≤5s 1mm from case	Tsd	260	°C

Basic Characteristics

Tamb = 25 °C

Parameter	Test Conditions	Symbol	Min	Typ	Max	Unit
Supply Voltage (Vs)	Recommended operating	Vs	2.5		5.5	V
Supply Current (Vs)	Vs = 5V	Is	0.7	1.1	1.4	mA
Transmission Distance	IR diode AT205, If=0.4A	d	20			m
Level Output Pulse Width	BurstWave=600μs, Period= 1.2ms Ee=0.3~200mW/cm <sup>2</sup>	TWH	500		800	μs
Level Output Pulse Width		TWL	500		800	μs
Directivity	Angle of 1/2 transmission distance	θ 1/2		±45		deg
Carrier frequency		fo		37.9		kHz
Peak Wavelength		λ		940		nm
Output Voltage Low		VOSL			250	mV

Characteristic Curve (Tamb=25°C unless otherwise specified)

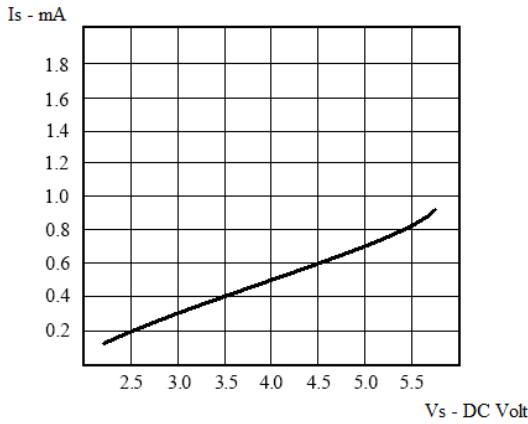

Fig. 1 Supply Voltage versus Current

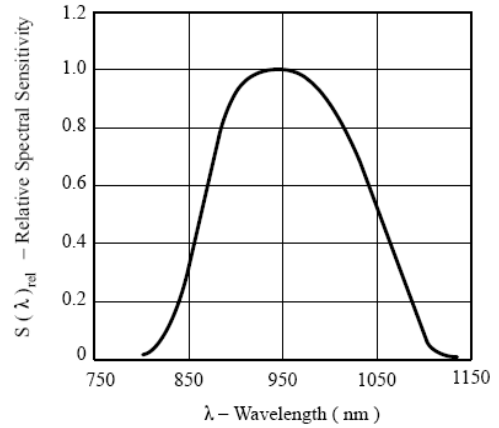

Fig 2 - Relative Spectral Sensitivity

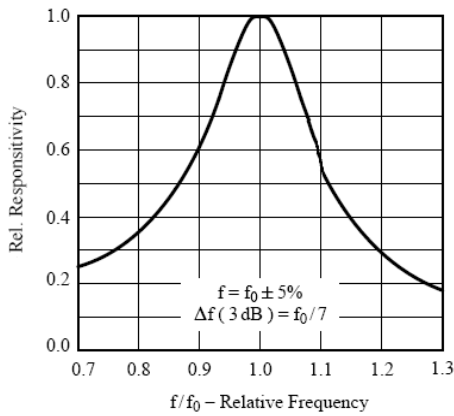

Fig. 3 - Carrier Band pass response

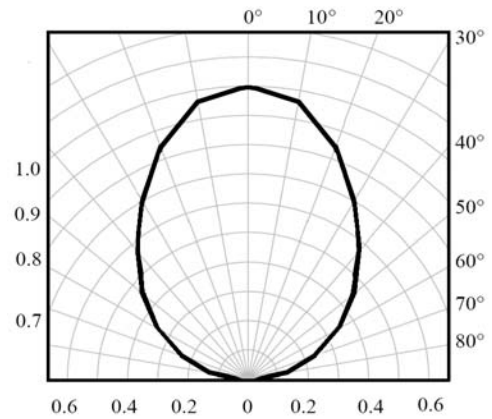

Fig. 4 - Directivity

**Reliability Test**

TEST ITEM	TEST CONDITION	TEST TIME	SAMPLE NUM	OK NUM
High Temperature Storage	Ta=+85°C	t=240H	22	22
Low Temperature Storage	Ta=-25°C	t=240H	22	22
Resistance to soldering heat	Soak into solder tub of Tsd=260°C	1 cycle 5sec	22	22
Electro Static Discharge	HBM C=100pF, R=1.5kΩ, 2kV,	each pin test once	22	22
High Temperature/Humidity*	Ta=+85°C, 90%RH	t=240H	22	22
Heat Cycle*	-25°C~+85°C(0.5H)	20cycle	22	22

**Note** : \*(electro-optical characteristics) shall be satisfied after leaving 2 hours in the normal temperature

## Package Outline

Dimensions in mm: tolerance  $\pm 0.3\text{mm}$

